

2x

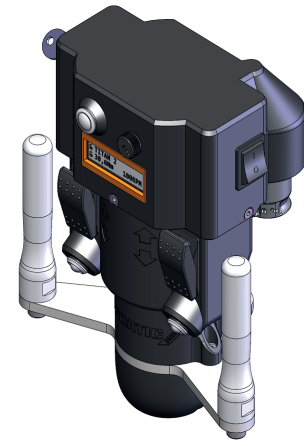

1x



1x



3,0 kg  
6,2 lb

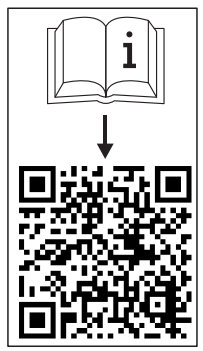

Quick-Start-Guide V 1.0 WorkBuddy 40Nm

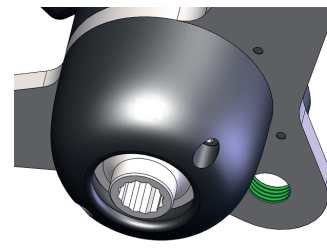
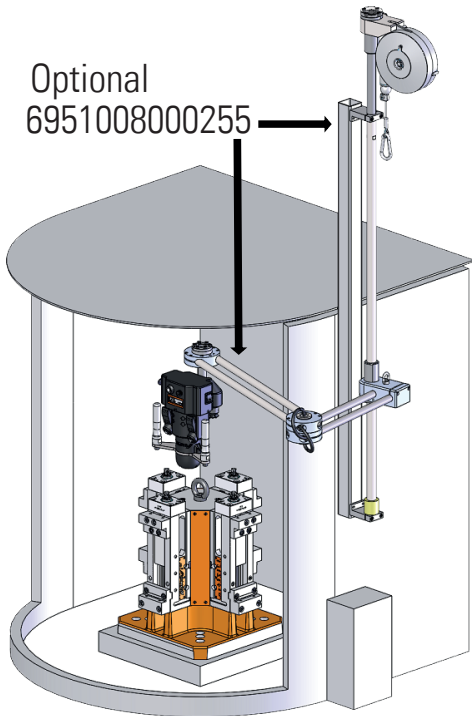







DIN475-SW14

Mehr Informationen/  
more information













	 	 F (N) M (Nm)
NC8 - 90		1 - 11
NC8 - (125 -200)*		0 - 4
DUO 90		1 - 6
DUO 125		0 - 4
TITAN 2		10,5 - 30,0 Nm
DUO Plus 125		14,0 - 40,0 Nm

\*NC8 ≅ LC/TC

	MAINTENANCE MODE Finished
	MAINTENANCE MODE Phase 2
	»DUO PLUS «40,0Nm /60RPM
	»DUO PLUS «40,0Nm /60RPM
	»DUO PLUS «40,0Nm /60RPM
	Operator's rank: »3 5 Nm «
	Finished Turn key to exit



			3
			2
			1
		$F(N)$ $M(Nm)$	